



Swimming Pool Systems

# MiniMax POOL & SPA HEATER

## OPERATION, INSTALLATION & SERVICE MANUAL

### FOR YOUR SAFETY - READ BEFORE OPERATING

**Caution:** If you do not follow these instructions exactly, a fire or explosion may result, causing property damage, personal injury or loss of life.

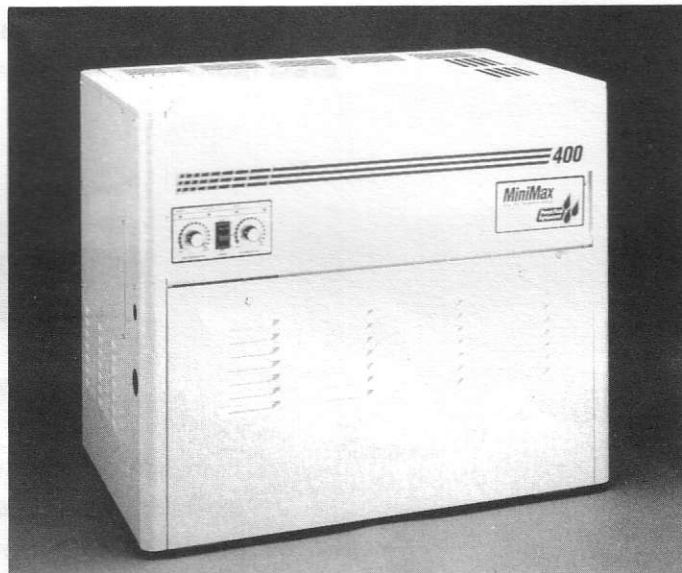

To  
Consumer  
Retain For  
Future  
Reference

U.S. Patent Numbers  
5,318,007 - 5,228,618  
5,201,307 - 4,595,825  
and European Patent Pending

**Warning:** Improper installation, adjustment, alteration, service or maintenance can cause property damage, loss of life or limb. Installation and service must be performed by a qualified installer, service agency or the gas supplier.

### FOR YOUR SAFETY

#### WHAT TO DO IF YOU SMELL GAS

- Do not try to light any appliance.
- Do not touch any electrical switch; do not use any phone in your building.
- Immediately call your gas supplier from a neighbour's phone. Follow the gas supplier's instructions.
- If you cannot reach your gas supplier, call the Fire Department.

Do not store or use gasoline or other flammable vapors and liquids in the vicinity of this or any other appliance.

# TABLE OF CONTENTS

## Introduction

Important Notice	i
Specifications	ii
Specifications - Technical Data	iii

## User Section

Introduction	1
Starting Operation	3
Operating Control	4

## Installation Section

Water Connections	5
Quick-Flange Installation	7
Water Header Manifold Reversal	8
Outdoor Installation Requirements	9
Indoor Venting Requirements	10
Gas Connections	12
Manifold Gas Pressure Adjustment	13
Electrical	14

## Service Section

General Maintenance Requirements	15
Heat Exchanger Maintenance	16
Burner Tray	19
Troubleshooting	21
Replacement Parts	26
Glossary	28

# MiniMax

## Pool and Spa Heater

Congratulations on your purchase of a MiniMax high performance heating system. Proper installation and service of your new heating system and correct chemical maintenance of the water will ensure years of enjoyment. The MiniMax is a compact, lightweight and efficient gas fired high performance pool and spa heater. The heater is equipped with features that take advantage of new technology developed exclusively for the MiniMax. This is the first pool heater that can be directly connected to schedule 40 PVC pipe and has a built-in top.

### IMPORTANT NOTICE

#### **Gas Safety (Installation and Use) Regulations, 1994**

It is the law that all gas appliances are installed by competent persons in accordance with the above regulations. Failure to install appliances correctly could lead to prosecution. It is in your own interest, and that of safety, to ensure that the law is complied with.

#### **General Requirements**

The appliance must be installed by a competent person ie. CORGI registered in accordance with the relevant requirements of the Gas Safety Regulations, current I.E.E. Regulations, Model Water Byelaws, Local Water Authority Byelaws and any relevant requirements of the local gas supplier, local authority and the relevant British Standard Codes of practice and Building Regulations. Manufacturers notes must not be taken in any way as overriding statutory obligations. Typical documents include:

BS. 6891; Installation of low pressure pipework.

BS.6644; Installation of Gas Fired Hot Water Boilers 60kW to 2MW.

CP341; Water Supply.

British Gas Publications:

IM2; Purging Procedures of Non-domestic Gas Installations.

IM5; Soundness Testing Procedures for Industrial and Commercial Gas Installations.

IM11; Flues for Commercial and Industrial Gas Fired Boilers and Air Heaters.

Model Water Byelaws.

# SPECIFICATIONS - Dimensions

## Outdoor Installation - Flueless

Model	"A" Dim
150	17 7/8"
250	23 7/8"
400	33 3/8"

Table 1

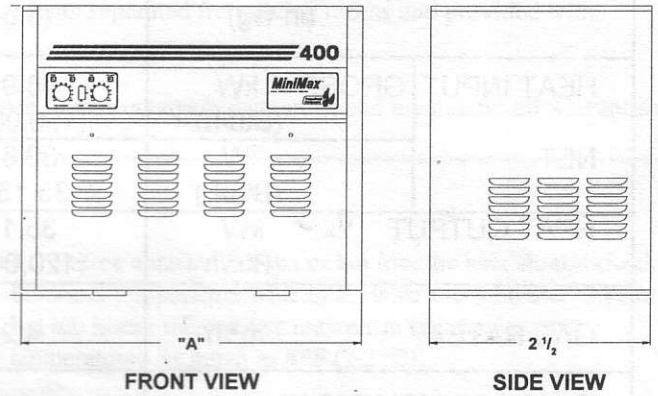

Fig. 1

## Indoor Installation - with draught divertor

Model	"A" Dim	"B" Dim	"C" Dim	"D" Dim
150	17 7/8"	6 1/2"	7 3/4"	39 3/4"
250	23 7/8"	12 1/2"	10"	42 3/4"
400	33 3/8"	22 3/8"	17"	51 3/4"

Table 2

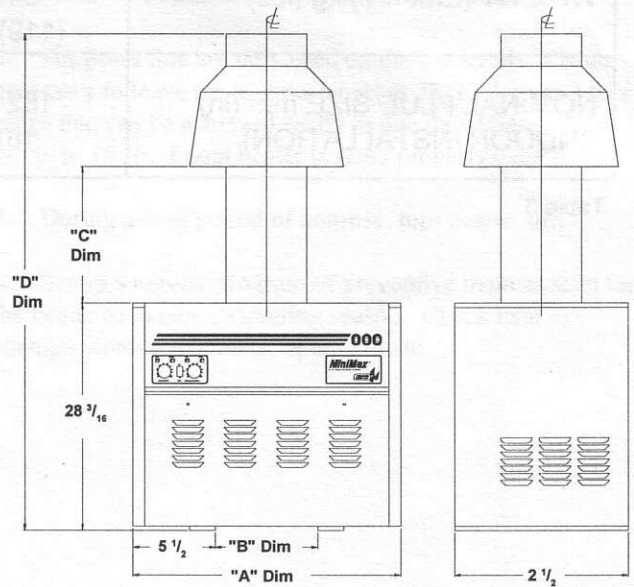

Fig. 2

## SPECIFICATIONS - Technical Data (Natural Gas Models Only)

MODEL		150	250	400
GAS CATEGORY, TYPE, AND SUPPLY PRESSURE		I <sub>2H</sub> G20 @ 20 mbar (8 IN.WG)		
BURNER PRESSURE mbar (in-wg)		8.9 (3.6)	8.9 (3.6)	8.9 (3.6)
HEAT INPUT	GROSS kW (Btu/h)	43.95 (150,000)	73.3 (250,000)	117.2 (400,000)
	NET kW (Btu/h)	39.6 (135,150)	66.0 (225,250)	105.6 (364,400)
HEAT OUTPUT kW (Btu/h)		35.16 (120,000)	58.64 (200,100)	93.76 (319,900)
GAS RATE m <sup>3</sup> /h		4.2	7	11.2
FLUE GAS VOLUME l/sec (7%CO <sub>2</sub> )		16.50	27.5	44
INJECTOR DIAMETER (mm) & I.D		3.45 29	3.45 29	3.45 29
MAX WATER PRESSURE bar (psi)		8 (125)	8 (125)	8 (125)
MAXIMUM WATER FLOW TEMP C		45	45	45
ELECTRICAL SUPPLY		240V~50Hz FUSED AT 5A		
WEIGHT (EMPTY) kg (lbs)		54 (119)	62 (137)	76 (167)
NOMINAL FLUE SIZE mm (in) (INDOOR INSTALLATION)		152 (6)	178 (7)	254 (10)

Table 3

## Introduction

---

This instruction manual provides operating instructions, installation and service information for the MiniMax high performance heater. The information in this manual applies to the MiniMax 150, 250 and 400 natural and propane (LP) models. Note that the British Gas Certification and the CE Mark apply only to the Natural gas models.

This heater is designed for the heating of fresh water swimming pools and spas, and should not be used for any other purpose. The heater must only be installed in the open air or in a room separated from living rooms and provided with appropriate ventilation directly to the outside.

The heater must be used only in accordance with these instructions. Incorrect use is dangerous and invalidates all warranties and certification.

---

## Safety Rules

1. Spa or hot tub water temperatures should never exceed 104 °F (40 °C). A temperature of 100 °F (38 °C) is considered safe for a healthy adult. Special caution is suggested for young children.
2. Drinking of alcoholic beverages before or during spa or hot tub use can cause drowsiness which could lead to unconsciousness and subsequently result in drowning.
3. Pregnant women beware! Soaking in water above 102 °F (39 °C) can cause fetal damage during the first three months of pregnancy (resulting in the birth of a brain-damaged or deformed child). Pregnant women should stick to the 100 °F (38 °C) maximum rule.
4. Before entering the spa or hot tub, the user should check the water temperature with an accurate thermometer. Spa or hot tub heater thermostats may err in regulating water temperatures as much as 4 °F (2.2 °C).
5. Persons with medical history of heart disease, circulatory problems, diabetes or blood pressure problems should obtain their physician's advice before using spas or hot tubs.
6. Persons taking medications which induce drowsiness, such as tranquilizers, antihistamines or anticoagulants, should not use spas or hot tub.

---

## Energy Saving Tips

1. If possible, keep pool or spa covered when not in use. This will not only cut heating costs, but also keep dirt and debris from settling in the pool and conserve chemicals.
2. In swimming pool applications, the pool heater thermostat setting should be 78 °F or lower. This is accepted as being the most healthy temperature for swimming by the American Red Cross.
3. Use an accurate thermometer.
4. When the proper maximum thermostat settings have been determined, tighten the thermostat knob stopper.
5. Set timeclock to start circulation system no earlier than daybreak. The swimming pool loses less heat at this time.
6. For pools that are only used on the weekends, it is not necessary to leave the thermostat set at 78 °F. Lower it to a range that can be achieved easily in one day. (Generally 10 °F to 15 °F, if pool heater is sized properly).
7. During a long period of non-use, turn heater off.
8. Set up a regular program of preventive maintenance for the heater each new swimming season. Check heat exchanger, controls, burners, operation etc.

**Preventive Maintenance Service/Maintenance work must only be conducted by a qualified professional.**

Purex Pool Products MiniMax heaters are especially designed for swimming pool and spa use. Most homeowners enjoy many years of trouble-free service. For continued trouble free service each swimming season, a qualified professional service engineer should be called to:

1. Remove and clean burner tray and pilot assembly.
2. Clean and retighten all wiring terminals.
3. Remove heater top and inspect heat exchanger for

soot deposit.

4. Remove inspection plate and return head to check for scale.
5. Clean and adjust pressure switch.
6. With burner tray removed, check fire box for cracks.

Whether or not scale is a problem, a yearly inspection is good preventive maintenance. If a minor problem should exist it is much better to catch it in the early stages rather than to incur extensive repair charges later on.

**WARNING: Should overheating occur or the gas supply fall to shut off, turn off the manual gas control valve to the appliance. Do not use this heater if any part has been under water. Immediately call a qualified service technician to inspect the heater and to replace any part of control system and gas control which has been under water.**

## LIGHTING/OPERATION - Natural/Propane

### FOR YOUR SAFETY: READ BEFORE LIGHTING MINIMAX

**WARNING: If you do not follow these instructions exactly, a fire or explosion may result causing property damage, personal injury or loss of life.**

- A. This appliance is equipped with an ignition device which automatically lights the pilot. Do not try to light the pilot by hand.
- B. BEFORE OPERATING smell all around the appliance area for gas. Be sure to smell next to the floor because some gas is heavier than air and will settle on the floor.
- C. Do not use this appliance if any part has been under water. Immediately call a qualified service technician to inspect the appliance and to replace any part of the control system and any gas control which has been under water.
- D. Never store any materials within the vicinity of the appliance or ventilation openings.

### SAFETY INFORMATION - IF YOU SMELL GAS, FOLLOW THESE RULES:

- 1. Shut off gas line or propane tank.
- 2. Immediately call your gas supplier from a neighbour's phone.
- 3. Follow the gas supplier's instruction.
- 4. If you cannot reach your gas supplier, call the fire department.
- 5. Do not light matches or lighter.
- 6. Do not try to light any appliance.
- 7. Do not touch any electrical switch. Do not use any phone in your building.
- 8. Open all doors and windows. (Indoors)

### STOP! Have you read the safety information?

#### TO LIGHT THE APPLIANCE

- 1. Set the thermostat to lowest setting. - refer to next page.
- 2. Push power switch off.
- 3. Wait five (5) minutes to clear out any gas. If you then smell gas, STOP! Follow the safety information. If you don't smell gas, go to next step.
- 4. Make sure pump is running and primed.
- 5. Push power switch on. (Either pool or spa mode.)
- 6. Set thermostat to desired setting.
- 7. The pilot should spark and the pilot should ignite, then heater will fire.
- 8. In new installations where the gas line hasn't been bled, the pilot and main burner combustion sequence may be slower than normal.
- 9. If the heater does not operate as it should, in a reasonable amount of time, read the Troubleshooting Guide portion of this manual.

#### TO TURN THE APPLIANCE OFF

- 1. Set the thermostat to lowest setting and turn off power switch.
- 2. Turn off all electric power to the appliance if service is to be performed.

If the appliance is to be turned off during a period when frost is likely, consult your service engineer/gas supplier to take the appropriate action. (Drain the system.)



# OPERATING CONTROL

For convenience and economy all MiniMax heaters are equipped with two thermostats on the front of the heater control panel.

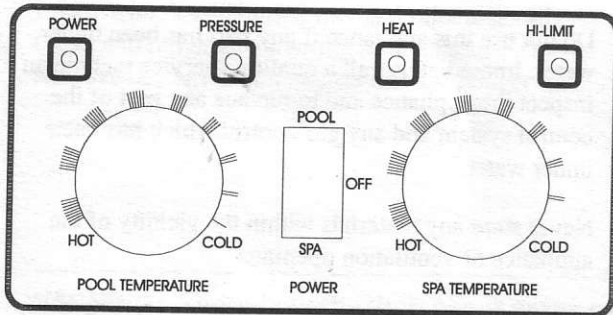

Fig. 3

The Pool/Off/Spa switch allows the heater to be turned off when heating is not desired.

1. "Pool" position - Maintains selected pool temperature.
2. "Off" position - Heater will not come on regardless of drop in pool temperature.
3. "Spa" position - This allows separate control of spa water temperature.

### SELECTOR DIALS

The selector dials eliminate constant thermostat adjustments. Set the spa dial at the desired spa temperature and the pool dial at the desired pool temperature. This provides convenient preset operating temperatures.

### "THERMOSTAT KNOB STOPPER"

Each thermostat is equipped with a mechanical stop (Fig. 4) that can be locked with use of a screwdriver to prevent temperatures in excess of that desired by the user.

The maximum setting can be adjusted by loosening the screw "A" and turning the stopper dial to desired maximum setting. Lock the setting by tightening the screw.

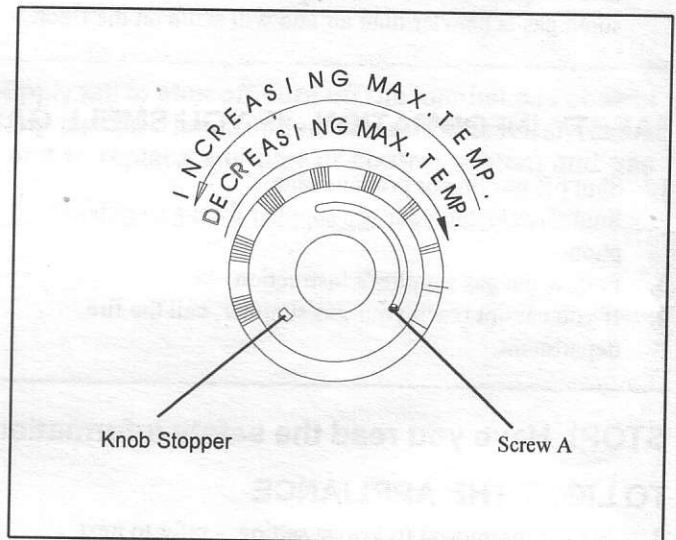

Fig. 4

### OVERHEAT THERMOSTAT

A manual re-set overheating thermostat is fitted adjacent to the flow header. If the appliance will not light, before contacting a service engineer, press the re-set button (Fig. 5) once.

If the overheat condition persists, or is repeated, contact your service engineer or gas supplier.

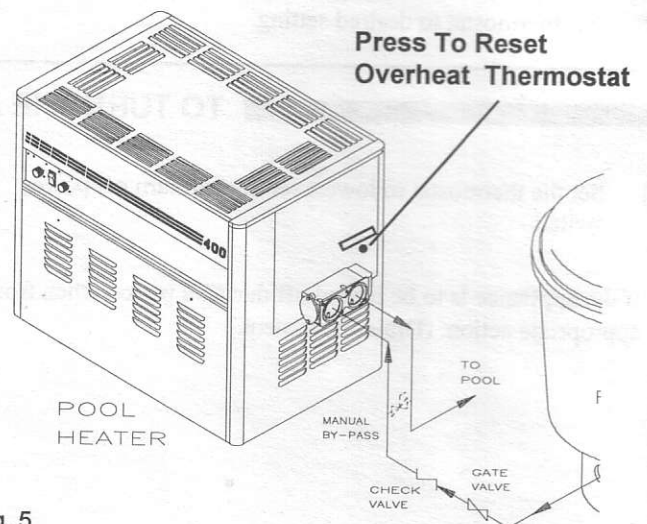

Fig. 5

# INSTALLATION INSTRUCTIONS - Water Connections

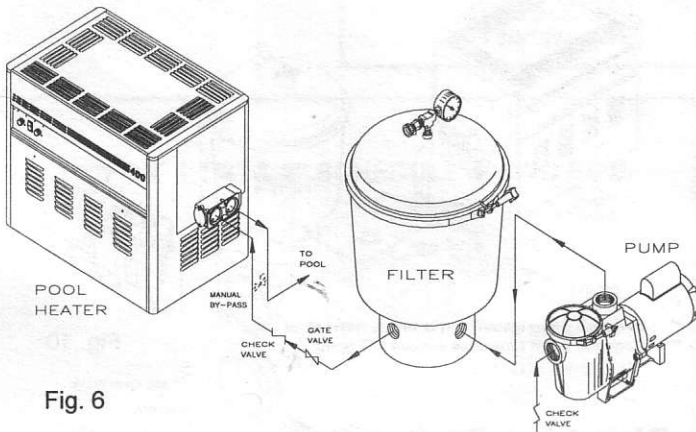

Fig. 6

## Accessibility

To assure easy access, plumbing should not be installed over the top of the heater. The water lines should come directly into the heater from the side or up from the ground.

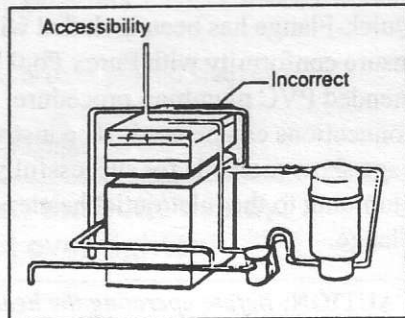

Fig. 7

## Below Pool Level Installations

Where a pool heater is to be installed below the water level of the pool, it is necessary to readjust the pressure switch to allow for the constant water pressure in the system. Gate valves should **NOT** be installed on the return line

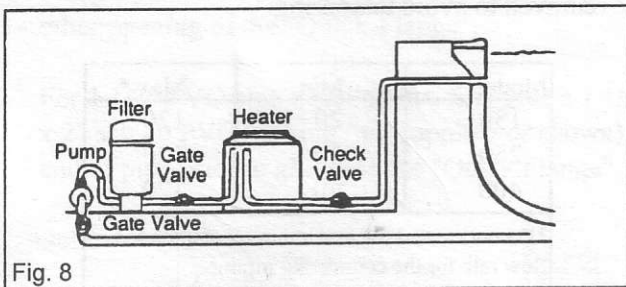

Fig. 8

from the heater. When the heater is installed below pool level, install a check valve after the heater and a gate valve between

**Caution:** Exercise care when installing chemical feeders so as to not allow back siphoning of chemical into heater, filters or pump.

Non Combustible flooring

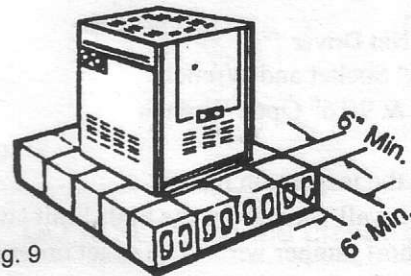
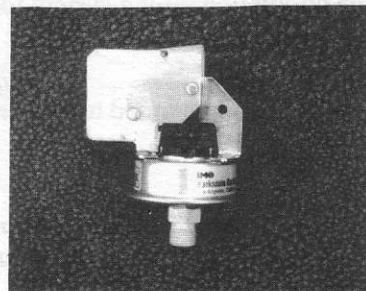

Fig. 9

**Note:** Heater must be installed on a non-combustible floor and at least six inches from any combustible material or wall. Before installing water pipe, check local building codes related to pool heaters.

## Heaters installed below water level require adjustment of the pressure switch.

1. Backwash filter and clean the pump hair and lint basket before making any adjustment to the pressure switch.
2. Turn on the circulation pump switch, the heater power switch and set the thermostat(s) to the hottest setting.
3. Turn the pressure switch adjustment knob clockwise until the heater turns off.
4. Turn the adjust knob 1/4 turn counter clockwise. The heater should come back on.
5. Turn the pump off. The heater should shut off with the circulation pump. If no, repeat steps 2, 3 and 4.
6. Use the circulation pump switch to turn the heater on and off several times to insure proper adjustments.



**Note:** If pool is more than 1 ft. above heater or vice-versa, the pressure switch may have to be replaced with a flow switch.

# INSTALLATION INSTRUCTIONS - Water Connections

## Reversible Inlet/Outlet Connection

The MiniMax is factory assembled with right side inlet/outlet water connections. The inlet/outlet header can be reversed for left side water connections without removing the heat exchanger.

### Reversing Water Connections Disassembly

Tools needed:

- 1/4" Nut Driver
- 9/16" Socket and Wrench
- 1/2" & 9/16" Open Wrench

1. Remove the inspection plates.
2. Disconnect all wires from the high-limit switches except short jumper wire. The exact order of disconnection is not important.
3. Disconnect the pressure switch tube from the in/out header.
4. Remove the temperature sensing bulb from the in/out header. **Note:** You may cut the wire bundle ties.
5. Exchange the in/out header with the return header. Replace the heat exchanger tube seals with new seals provided.
6. Install the temperature sensing bulb by passing the wires through the hole provided on the left side of brace panel. Route wires through support bracket.
7. Install the pressure switch tubing into the in/out header by passing it above the brace panel.
8. Reconnect all high limit wires. The order of connection is not important. Route the wires through the same hole as the thermostat sensor wires.
9. Reinstall the inspection plates.

## Plumbing

### Valves

- When any equipment is located below the overflow rim of the pool or spa, valves should be placed in the circulation piping system to isolate the equipment from the pool or spa.
- Check valves are recommended to prevent back siphon.

**Caution:** Exercise care when installing chemical feeders so as to not allow back siphoning of chemical into the heater, filters or pump.

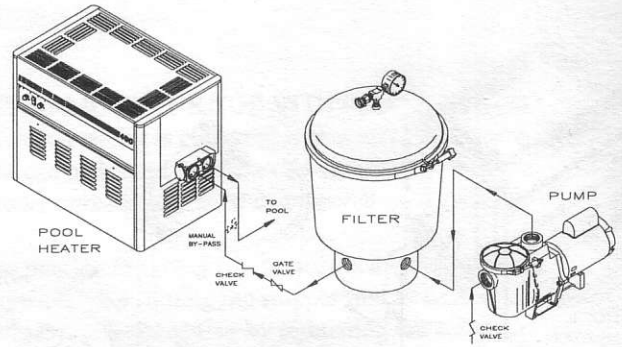

- \* Required when installation is below water level
- \*\*\* Required when flow rates exceed 120 gpm.

Fig. 10

\*\* ISOLATION VALVE FROM POOL

## Plumbing Connections

The MiniMax heater has the unique capability of direct schedule 40 PVC plumbing connections. A Quick-Flange has been included with the MiniMax to insure conformity with Purex Pool Systems recommended PVC plumbing procedure. Other plumbing connections can be used. The instructions on the next page show methods for successfully connecting plumbing to the inlet/outlet header, with the Quick-Flange.

**CAUTION:** Before operating the heater on a new installation, turn on circulation pump and bleed all air from the filter using the air relief valve on top of the filter. Water should flow freely through heater.

**Do not operate the heater unless water in pool/spa is at proper level.**

## Manual By-Pass

Where the flow rate exceeds the maximum 120 gpm a manual by-pass should be installed and adjusted. After adjustments are made, the valve handle should be removed to avoid tampering.

Model	Min.	Max.*
150	20	120
250	30	120
400	40	120

\*Do not exceed the maximum recommended flow rate for the connecting piping.

Table 3

## Below Pool Installation

If the heater is below water level, the pressure switch must be adjusted. **This adjustment must be done by a qualified service technician.**

# Quick-Flange Installation Instruction Sheet

Each MiniMax Quick-Flange Kit contains:  
 1 - Quick-Flange unit      2 - 2" Rubber gaskets  
 4 - 3/8 Bolts                2 - 1 1/2" Rubber gaskets  
 4 - 3/8" Washers            2 - Plastic sleeves

### FOR 1 1/2" & 2" SCHEDULE 40 PVC PIPE

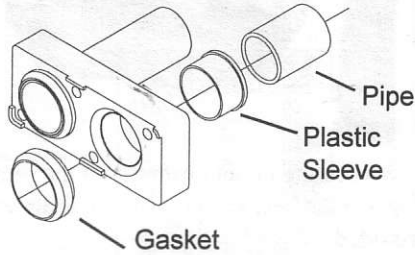

Fig. 11

1. Insert plastic sleeves into the "Quick Flange" inlet and outlet openings.
2. Slip rubber gaskets over plastic sleeves.
3. Bolt the "Quick-Flange" to the header.

**NOTE: Tighten the bolts evenly!  
Do not over tighten!**

4. Use plumbers roll or medium grit sand paper and clean the inlet/outlet openings of the "Quick-Flange". Use the same method to clean the PVC pipe. The sand paper open will break up any grease or contaminant that may not be cleaned away with a primer.
5. Use 711 PVC (or comparable glue) and follow manufacturer's recommendations. Apply to the inlet opening of the "Quick-Flange". Do the same to the PVC pipe and **quickly** insert pipe into "Quick-Flange" and twist pipe 1/4 turn. Do the same to the other opening of the "Quick-Flange".
6. For 1 1/2" PVC pipe installations, first glue a 1 1/2" x 2" sch 40 PVC bushing (not supplied or shown) to end of pipe prior to gluing to the "Quick Flange".

### FOR 1 1/2" & 2" COPPER PIPE

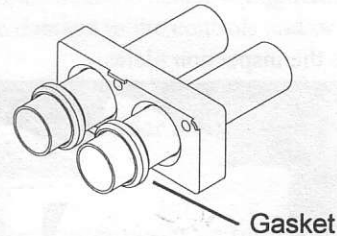

Fig. 12

You **"DO NOT"** need the plastic sleeves. \*

1. Insert pipe into inlet/outlet opening of the "Quick-Flange".
2. Slip the rubber gasket over the pipe, using the 2" rubber gasket for 2" copper pipe or the 1 1/2" rubber gasket for 1 1/2" copper pipe.
3. Bolt the "Quick-Flange" to the header.

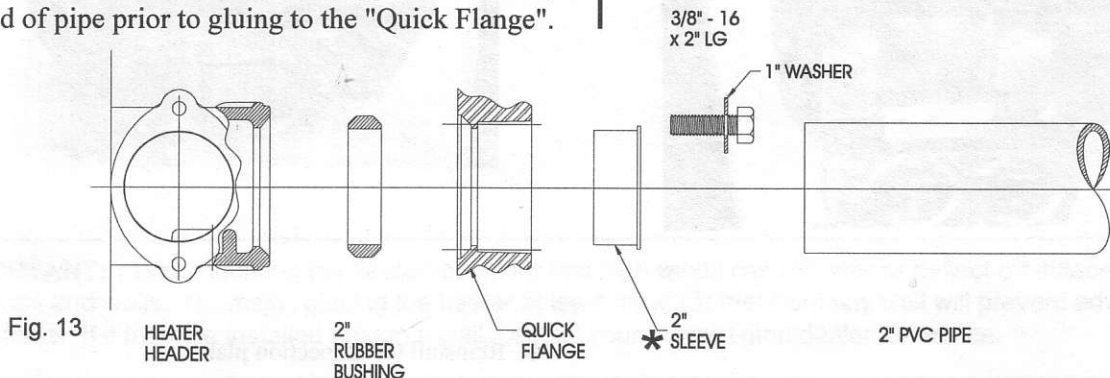

Fig. 13

HEATER  
HEADER

2"  
RUBBER  
BUSHING

QUICK  
FLANGE

2"  
\* SLEEVE

2" PVC PIPE

3/8" - 16  
x 2" LG

1" WASHER

# INSTALLATION INSTRUCTIONS - Water

## Reversible Inlet/Outlet Connections

The MiniMax is factory assembled with right side inlet/outlet water connections. The inlet/outlet header can be reversed for left side water connections without removing the heat exchanger.

1. Remove the inspection plates.

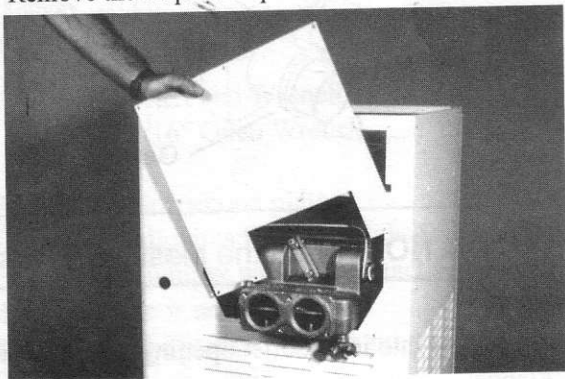

2. Disconnect all wires from the high-limit switches except short jumper wire. Disconnect the pressure switch tube from the in/out header. Remove the temperature sensing bulb from the in/out header.

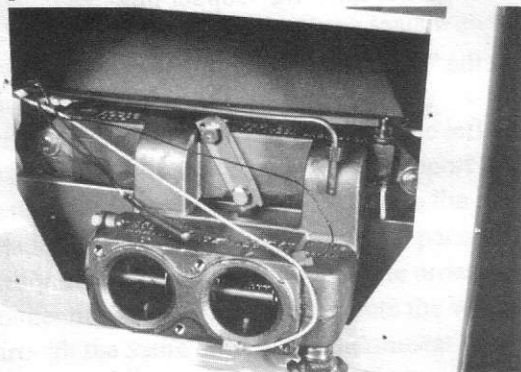

3. Remove in/out header bolts.

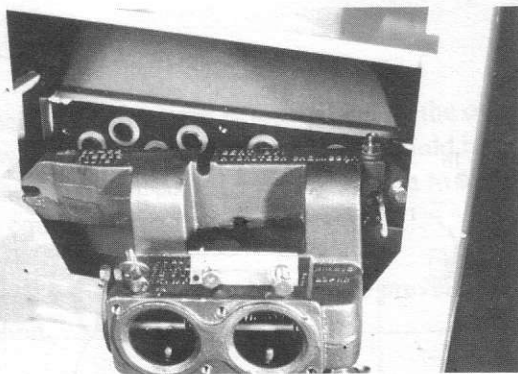

4. Remove return header.

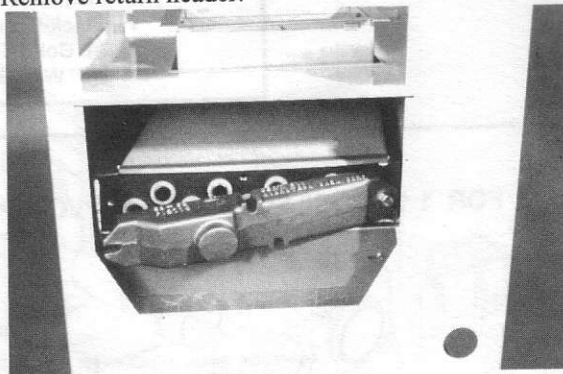

5. Switch the in/out header with the return header. Replace the heat exchanger tube seals with new seals provided.

6. Install the temperature sensing bulb and hi-limit wires by passing them through the hole provided on the left side of front panel.

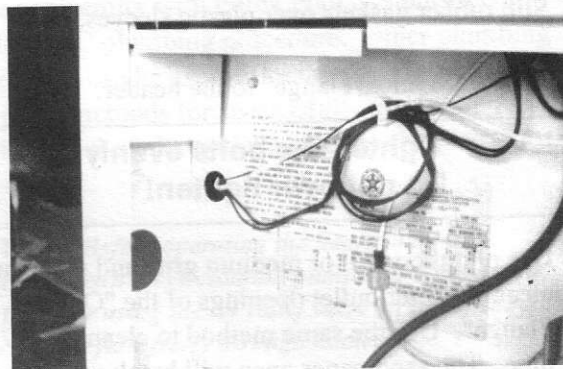

7. Reconnect all high-limit wires. The order of connection is not important. Route the wires through the same hole as the thermostat sensor wires. Reroute and install the pressure switch tubing behind the control box and into the in/out head.

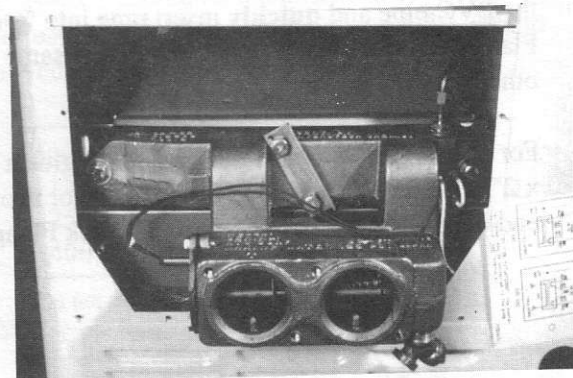

8. Reinstall the inspection plates.

# INSTALLATION INSTRUCTIONS - Outdoor

The heater should not be installed closer than 6 inches to any fences, walls or shrubs at any side or back, nor closer than 18 inches at the plumbing side. A minimum clearance of 24 inches must be maintained at front of heater.

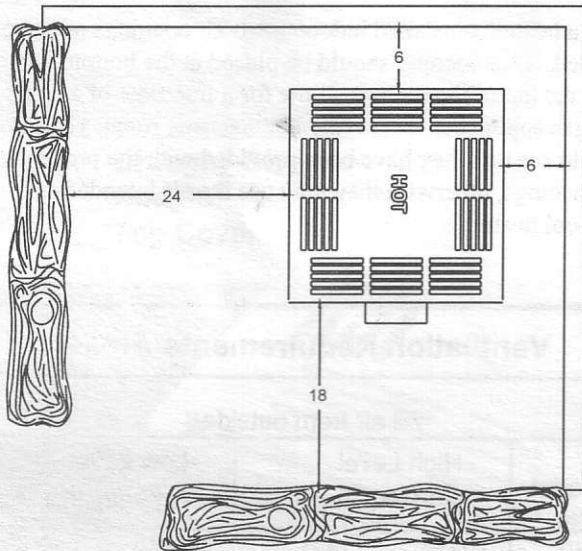

Fig. 14

**Do not install** the heater in locations which will permit the accumulation of leaves or other combustible material around the base of the heater.

**Do not install** the heater in a location that will allow sprinklers to operate near the heater equipment since the water may cause damage to the controls and/or electronics.

**Do not install** directly under any roof mounted gutter.

**Do not install** the heater under an overhang of less than three (3) feet from the top of the heater. The area under the overhang must be open on three sides. Overhangs must be such that flue products are not diverted into living spaces. Heaters installed under overhangs must be protected from direct roof water drainage by gutters and the like. From the point where the flue products leave the heater, that point **MUST** be a minimum of four (4) feet below, four (4) feet horizontally from or one (1) foot above any door, window or gravity inlet to a building.

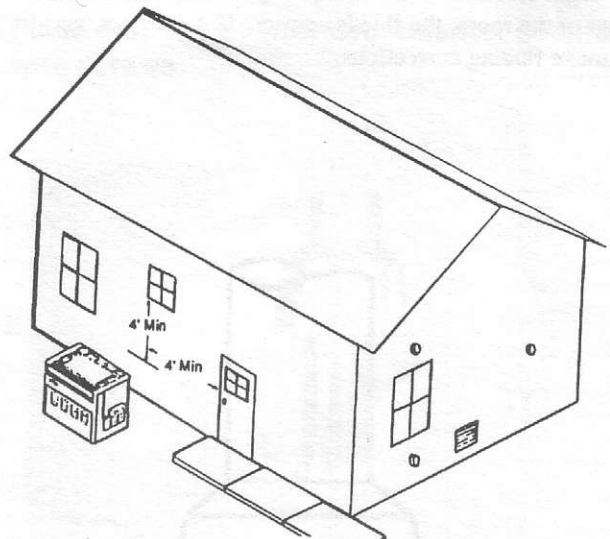

Fig. 15

**IMPORTANT:** When locating the heater, consider that high winds can roll over or deflect off adjacent buildings and walls. Normally, placing the heater at least three (3) feet from any wall will prevent adverse conditions. If it must be installed next to a wall, consult your Purex/Triton dealer for advice.

# INSTALLATION INSTRUCTIONS - Indoor

## Flue Requirements

A flue extension of the same size must be connected to the draft diverter and extended two feet above any obstacle within a 10 foot radius of the flue. The flue should then be fitted with a suitable terminal. **NOTE:** Do not alter the heater draught diverter in any way; it has been designed by the manufacturer and approved by British Gas plc. To ensure efficient flueing, use 45° Elbow for horizontal installation when attaching flue pipe to draught diverter.

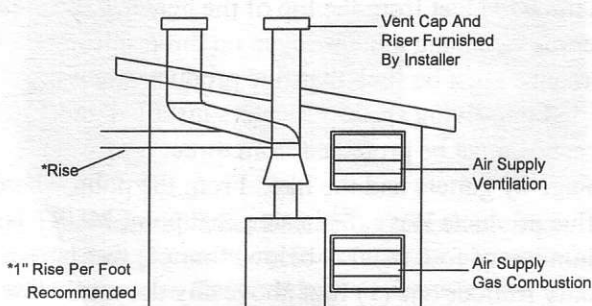

Fig. 16

A quick check of your flue installation. Allow heater to operate for 15 minutes. Then strike a wooden match and blow out the flame. With the match smoking, hold next to the draught diverter. If the smoke is pulled up into the flue and out of the room, the flue is correct. If it does not, you must make flueing corrections.

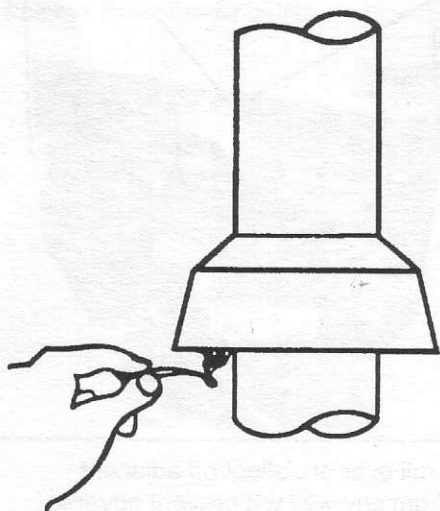

Fig. 17

## Air Supply Requirements

When a heater is installed indoors, two air openings must be provided. One opening should be placed at the bottom and one at the top of the room to allow for a free flow of air. If other gas appliances are installed in the same room, you must check to see that they have been provided with the proper size openings, otherwise they may use the air intended for your pool heater.

Ventilation Requirements Area			
All air from outside			
Model No.	High Level Cm <sup>2</sup> (sq. in.)	Low Level Cm <sup>2</sup> (sq. in.)	
150	270 (42)	540	(84)
250	300 (46)	600	(92)
400	400 (62)	800	(124)

Table 4



It is essential that the ventilation is direct from outside. The appliance must not be installed in a room directly or indirectly connected to a living space.

# INSTALLATION INSTRUCTIONS - Assembling Draught Divertor

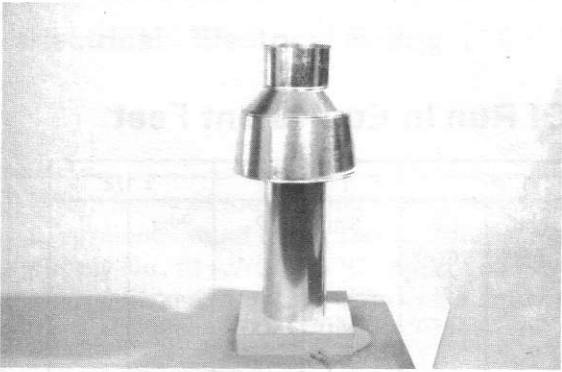

Parts: Draught Divertor  
Adaptor  
Top Cover

Place draught hood adaptor over flue collector.  
Secure with screws.

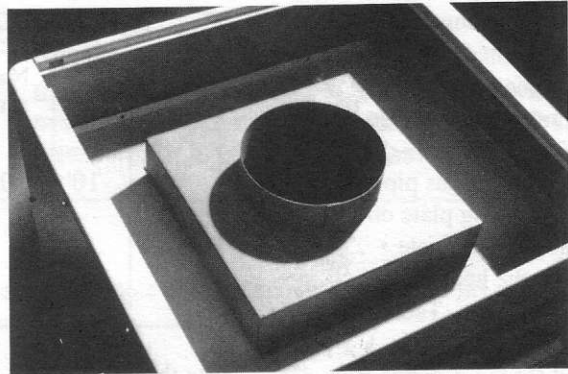

Install cover.

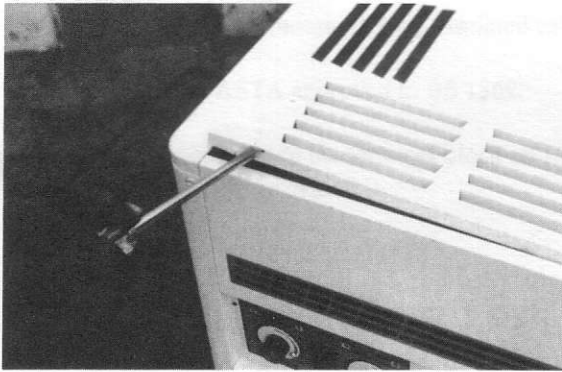

Remove stackless top.

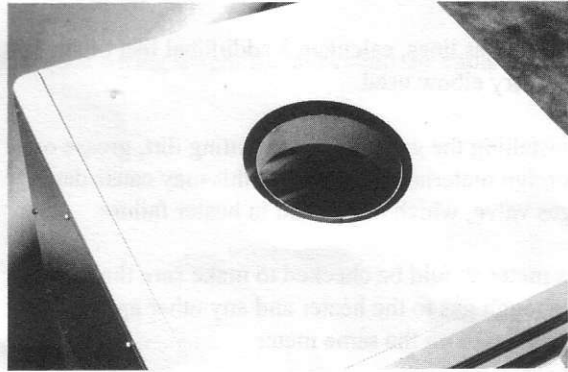

Place draught divertor over adaptor secure  
with screws.

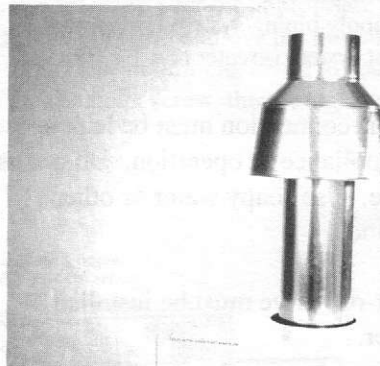
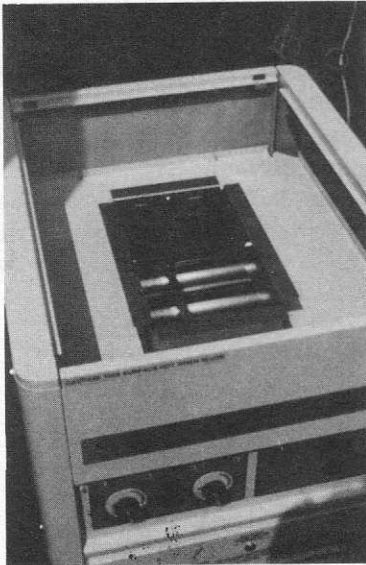

Do not install gas line until heater  
is installed. This will void your warranty.



**INSTALLATION INSTRUCTIONS - Gas Connections**

**Pipe Sized For Length Of Run In Equivalent Feet**

Before installing the gas line, be sure to check what gas the heater has been designed to burn. This is important because different types of gas require different gas pipe sizes. The rating plate on the heater will indicate which gas the heater is designed to burn. Table 5 shows what size pipe is required for the distance from gas meter to the heater. The table is for natural gas at a specific gravity of .65 and propane at specific gravity of 1.5.

Model	1/2"		3/4"		1"		1 1/4"		1 1/2"	
	Nat	LP	Nat	LP	Nat	LP	Nat	LP	Nat	LP
150	10'	40'	50'	150'	150'	600'	-	-	-	-
250	-	10'	20'	50'	70'	150'	250'	500'	600'	-
400	-	-	-	10'	20'	60'	100'	150'	200'	450'

Table 5

When sizing gas lines, calculate 3 additional feet of straight pipe for every elbow used.

When installing the gas line, avoid getting dirt, grease or other foreign material in the pipe as this may cause damage to the gas valve, which may result in heater failure.

The gas meter should be checked to make sure that it will supply enough gas to the heater and any other appliances that may be used on the same meter.

The gas line from the meter will usually be of a larger size than the gas valve supplied with the heater. Therefore a reduction of the connecting gas pipe will be necessary. Make this reduction as close to the heater as possible.

The heater and any other gas appliances must be disconnected from the gas supply piping system during any pressure testing on that system (greater than 1/2 PSIG).

The heater and its gas connection must be leak tested before placing the appliance in operation. Do not use flame to test gas line. Use soapy water or other nonflammable method.

A manual main shut-off valve must be installed external to the heater.

**It is essential that the natural gas appliance is supplied with a governed gas supply.**

**Do not install gas line union inside heater cabinet. This will void your warranty.**

## INSTALLATION INSTRUCTIONS - Electrical

**Electrical - Electrical Rating 230 V AC 50 Hz fused at 5A**

**Note:** If any of the original wiring supplied with is appliance must be replaced, installer must supply No. 18 AWG 105 °C., approved low energy stranded copper wire or it's equivalent.

**Caution:** The heater must be electrically grounded and bonded in accordance with local codes or, in absence of local codes, with the latest national electrical codes.

This appliance must be connected to the main supply via a fused double pole switch, having a 3mm (1/8 in) contact separation in both poles, serving only the heater, pump, and any external controls.

Wiring should be a minimum of PVC insulated cable not less than 24/0.2 mm to BS 6500 table 16.

All fuses must be ASTA approved to BS 1362.

Connect the main cable to the terminal block on LHS of appliance (see wiring diagram), and clamp the cable in position using the cable clamp provided.

This appliance **MUST** be EARTHED.

## COMMISSIONING THE APPLIANCE

Natural Gas Models Only: Manifold Gas Pressure

Test the installation for gas soundness, then light the appliance as described in the User's section, and check the burner manifold pressure as follows:

1. Turn the power supply OFF.
2. Connect a manometer to the burner manifold test point.
3. Light the heater and allow it to run for 10 minutes to stabilize the burners.
4. Check the pressure and if necessary, adjust it to the figure shown in Table 3 for the appropriate heater size. The location of the manifold pressure setting adjuster on the gas control is shown below. Remove the dustcover over the adjust and, using a small screwdriver, turn the screw beneath clockwise to increase or anti-clockwise to decrease the pressure.
5. Turn the appliance OFF, remove the pressure gauge, tighten the test point screw, then re-light and test for gas soundness.

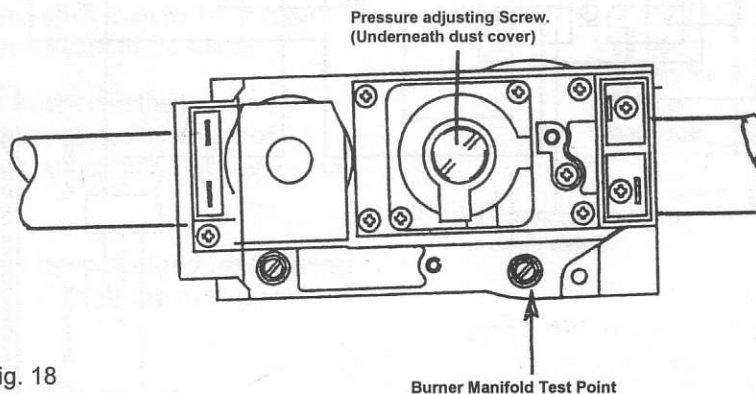
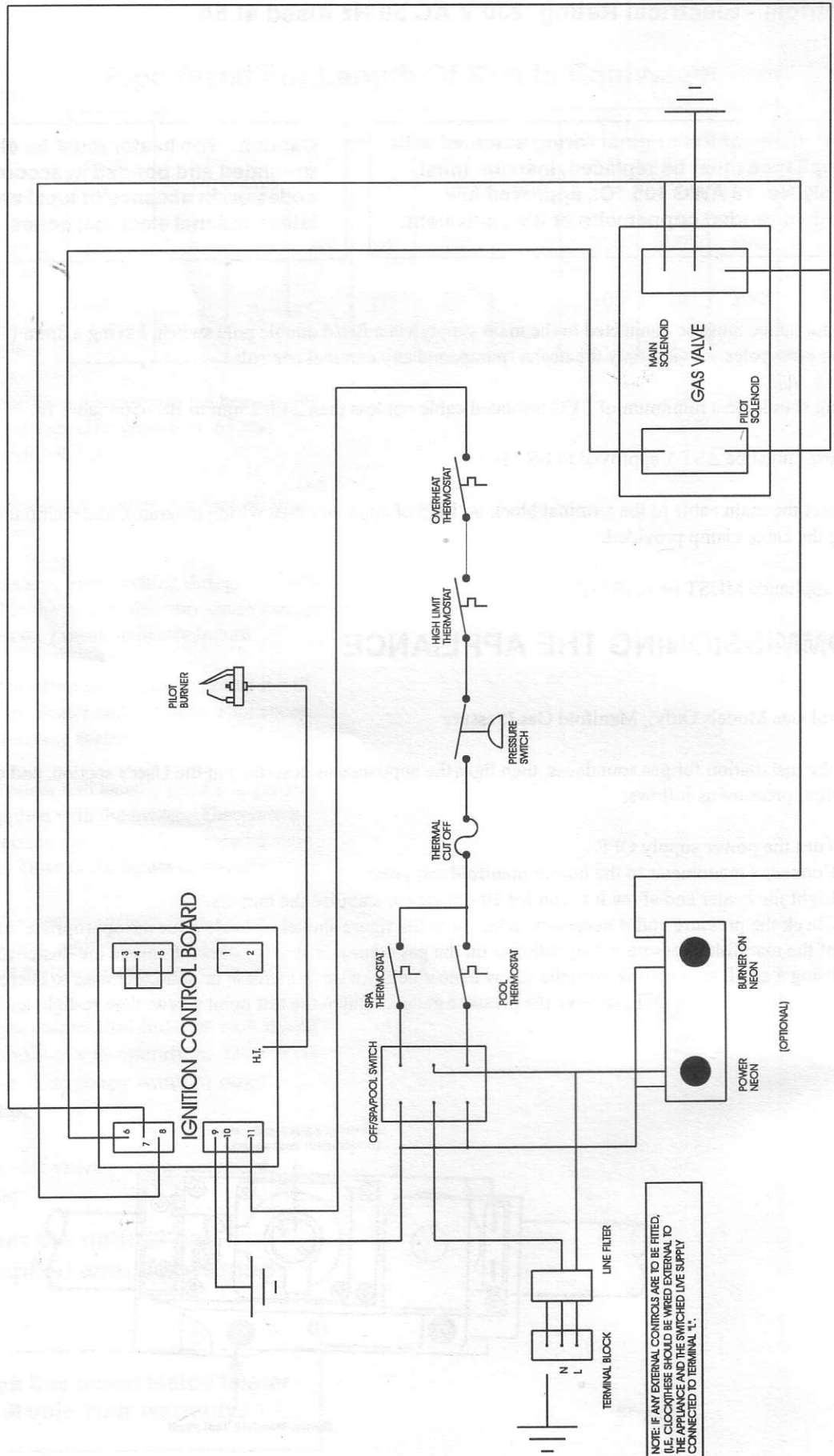

Fig. 18

**INSTALLATION INSTRUCTIONS - Electrical Circuit**



NOTE: IF ANY EXTERNAL CONTROLS ARE TO BE FITTED, (I.E. CLOCKS) THESE SHOULD BE WIRED EXTERNAL TO THE APPLIANCE AND THE SWITCHED LIVE SUPPLY CONNECTED TO TERMINAL "L".

# MAINTENANCE - To be conducted only by a qualified Professional

## Maintenance Instructions:

It is recommended that you check the following at least every six months and at the beginning of every swimming season.

1. Examine the Flue system. Make sure there are no obstructions in the flow of combustion and ventilating air.
2. Inspect the heat exchanger for soot. Clean as necessary.
3. Visually check the burner and pilot flame. When flame

appears yellow, burners should be inspected and cleaned.

4. Keep the heater area clean and free from combustibles and flammable liquids.
5. Check wire ends and wire connections. They should be clean and tight.
6. Check the burner manifold pressure as described in the previous section.

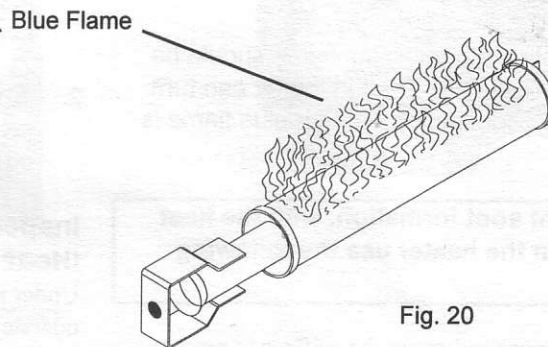
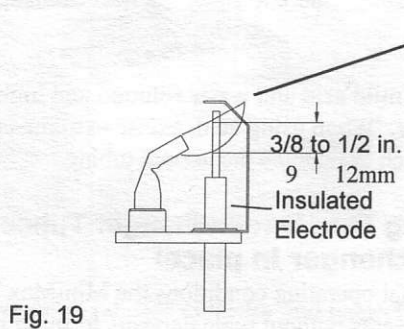

## Spring and Autumn Operation

If the pool is being used occasionally, do not turn the heater completely off. Set the thermostat down to 65 ° F. This will keep the pool and the surrounding ground warm enough to bring the pool up to a comfortable swimming temperature in a shorter period of time.

## Winter Operation

If the pool won't be used for a month or more, turn the heater off at the main gas valve. Where freezing is possible, it is necessary to drain the water from the heater. This may be done by opening the drain valve located at the inlet/outlet header allowing all water to drain out of the heater. Use compressed air to blow the water out of the heat exchanger. Also, disconnect the pressure switch from its 1/4" copper line. This will prevent freeze damage to the switch.

**Note:** Uncirculated water trapped in the heater can result in freeze damage to the heat exchanger or headers. Freeze damage is specifically not covered by the warranty.

**Caution:** If the heater has been drained for freezing condition, do NOT turn "on" until the system is circulation water.

## Relief Valve

In some installations a relief valve is required on the MiniMax.

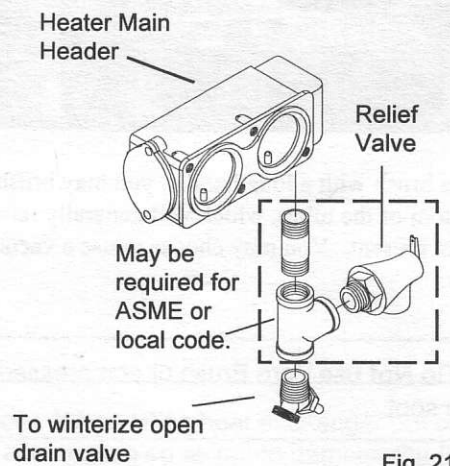

## MAINTENANCE

### Soot Formation on the Heat Exchanger

#### Usual Causes of Sooting:

1. Low gas pressure in the gas supply line.
2. Excessive water flow can create condensation which can cause a soot formation.
3. Foreign material in burners and orifices. (Remove foreign material such as dirt, spider webs, etc.)
4. Inadequate air supply for the heater, when installed indoors, can cause a soot formation.

**Note:** After de-sooting a heater, the flame should be blue in color, NOT YELLOW. Dust in the air can turn the flame yellow. A slight yellow tip on a blue flame is OK.

**To remove a light soot formation, with the heat exchanger still in the heater use the following procedures.**

1. Remove the burners and cover the orifices to protect against dirt or other material.
2. Remove flue collector and baffles.

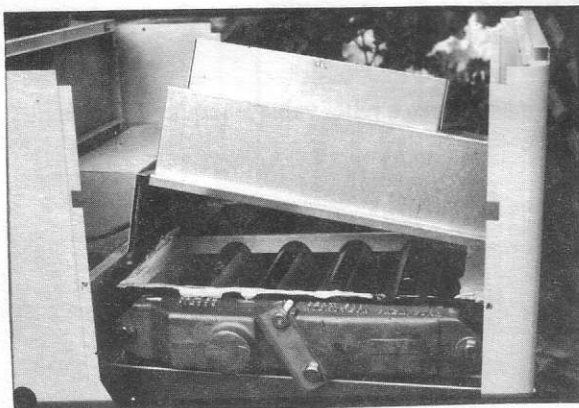

3. Using a brush with a long handle, you may brush off the bottom of the tubes, which will generally remove any soot present. You may choose to use a vacuum cleaner.

**Note: Do Not** use Wire Brush or compressed air to remove soot.

4. Brush off and clean all burner heads using caution not to damage burner ports.

5. Replace burners and test fire heater.

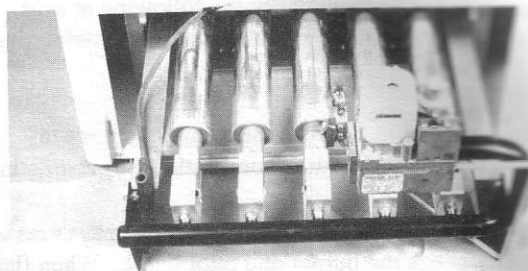

1. Powdered detergent and scrub brush accompanied by high water pressure to spray the heat exchanger thoroughly.
2. A very mild acid and water solution and high water pressure. When using acid, exercise extreme caution so as to not etch or damage the copper tubing.

### Inspecting The Heat Exchanger Tubes (Heat Exchanger in place)

Under normal operating conditions the MiniMax heater will operate for years without scale deposits forming in the tubes. In some pools, however, the mineral content of the water is such that completely scale-free operation is next to impossible. For this reason, the MiniMax pool heater has been designed so that the heat exchanger can be easily inspected without disassembling the entire unit. Inspection of the tubes at regular intervals is good assurance of longer life and less maintenance. To inspect the tubes for scale deposits, use the following procedure:

1. Remove inspection plate.
2. Remove the four (4) bolts holding the return head in place.
3. Remove the return head and visually inspect the tubes.
4. Replace tube gaskets.

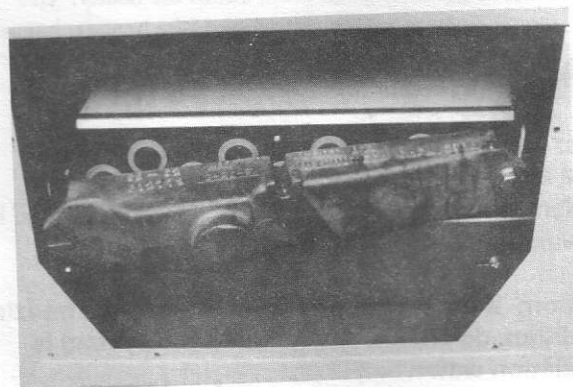

**To protect eyes from soot or cleaning solution use safety eye wear.**

## MAINTENANCE - Removing The Heat Exchanger

For heavy soot accumulation which cannot be successfully removed by merely brushing or use of a vacuum cleaner, the heat exchanger must be removed from the heater.

1. Turn off main gas to heater.
2. Turn pump off. Be sure that the stops on the clock will not allow the pump to come on during inspection or while the heat exchanger is removed.
3. Remove the top from the heater.

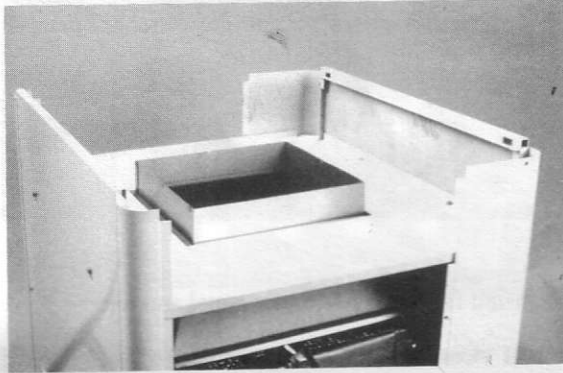

4. Remove inner lid, flue collector and inspection panels.

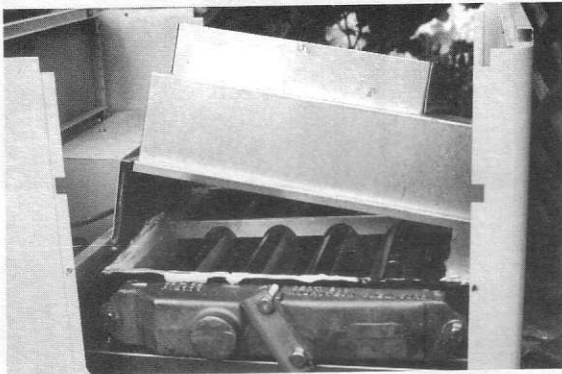

5. Disconnect the plumbing at the break away flanges and the pressure switch line. Remove the thermostat bulb and hi-limit wires from the inlet outlet header.

7. Remove the heat exchanger mount screws on the side of the heater.

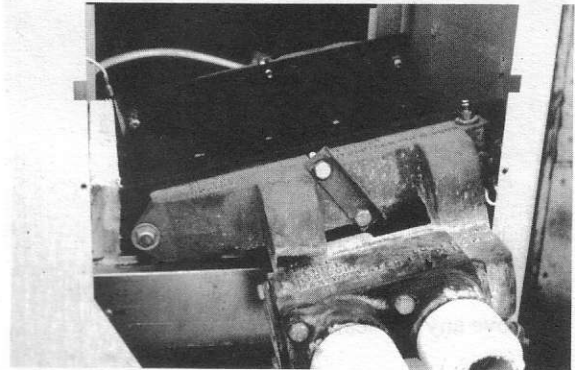

8. Lift heat exchanger out of heater.

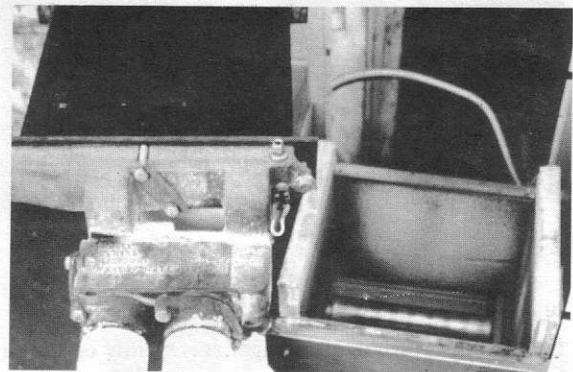

**Caution:** When lifting heat exchanger out of the fire brick, use caution so as not to damage the fire brick.

## MAINTENANCE - Reinstalling Heat Exchanger

1. Inspect fire box for damage or cracks that would allow heat to leak out into the outer cabinet and controls.
5. Reconnect the inlet and outlet flange to the headers (use new flange gaskets) careful not to move the heat exchanger and break the seal.

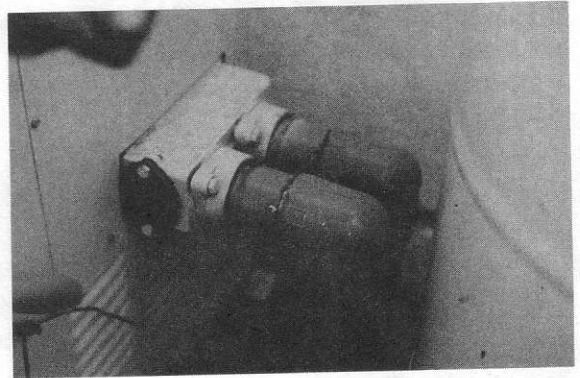
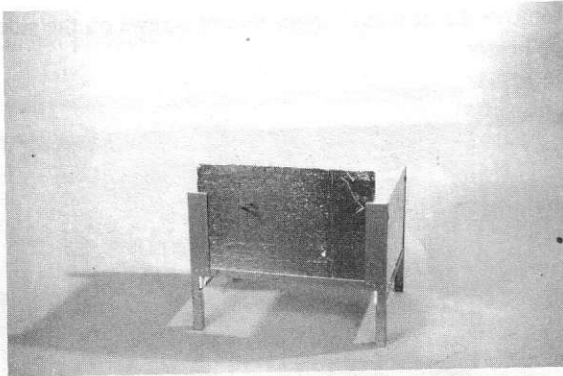

2. Remove any old sealant from fire box.
3. Apply new sealant to the fire box (Silicone Rubber Industrial Grade R.T.V.) or equivalent. The sealant must completely seal the space between the heat exchanger and fire box, so that when the heaters is firing, heat does not escape to the outer cabinet.

6. Reinstall flue collector, inner panel and top.

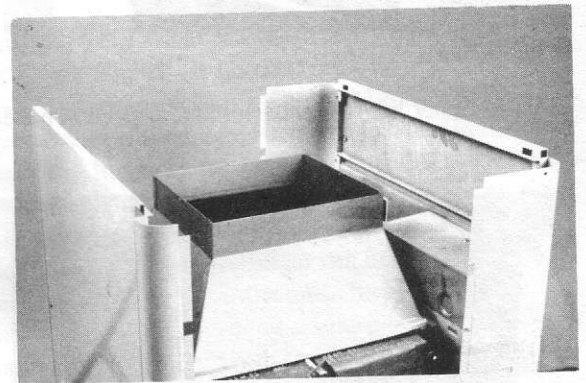

4. Place heat exchanger into the box and push down firmly, until the heat exchanger sets solidly on the fire box.

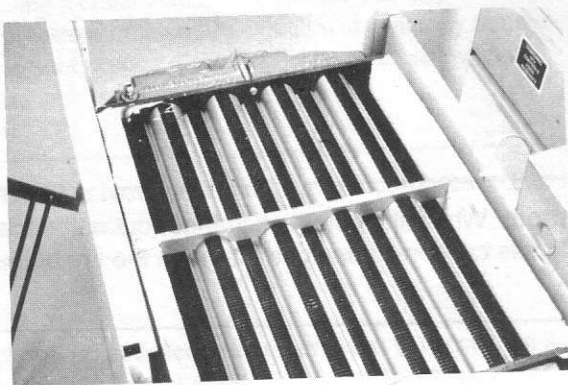

**Caution: When lifting heat exchanger out of the fire brick, use caution so as no to damage the fire brick.**

## MAINTENANCE - Burner Tray Removal & Disassembly

At some time during the life of a heater, you may need to inspect and repair the parts of the heater that allows the gas to flow from the gas supply line into the burners. If the heater won't fire and you wish to check these gas controls:

1. Turn off gas supply.

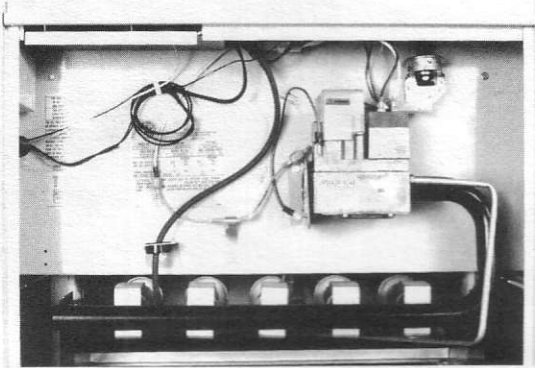

2. Disconnect the gas union at the heater.
3. Remove the gas line installed into the gas valve.
4. Remove gas valve holding bracket.
5. Remove gas valve wires.
6. Disconnect the ignition wire.
7. Slide the burner tray out.

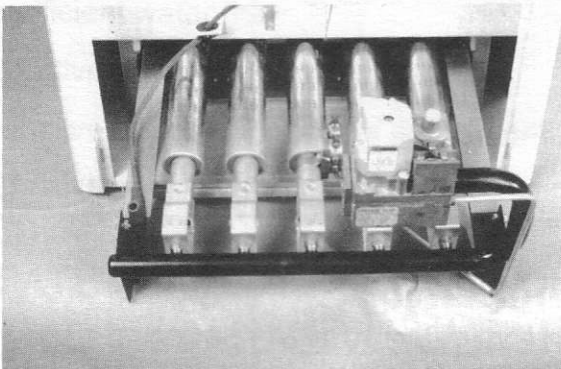

8. You can remove the gas valve if you need to check the inlet and outlet screens. (You will have to remove pilot tubing.)

9. Remove the bracket the bracket that holds the burner in place.

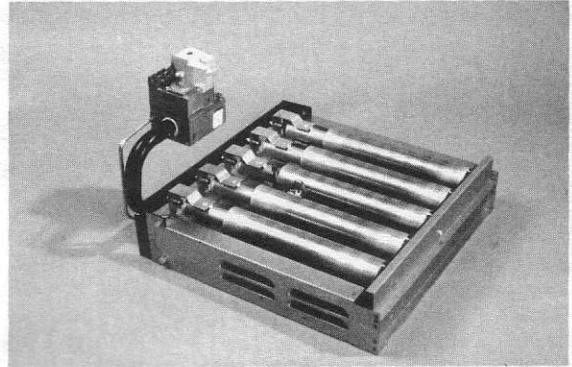

10. Remove each burner and check for any blockages.

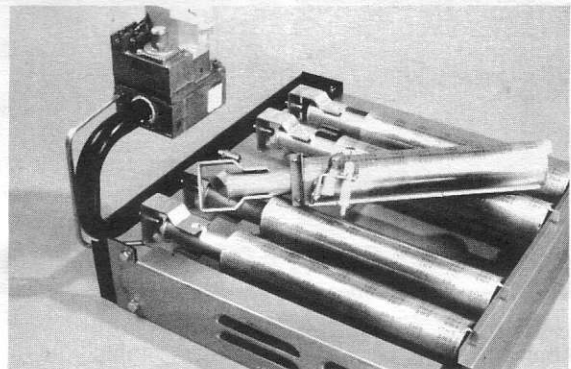

11. Remove the main burner orifices and check for any blockage.

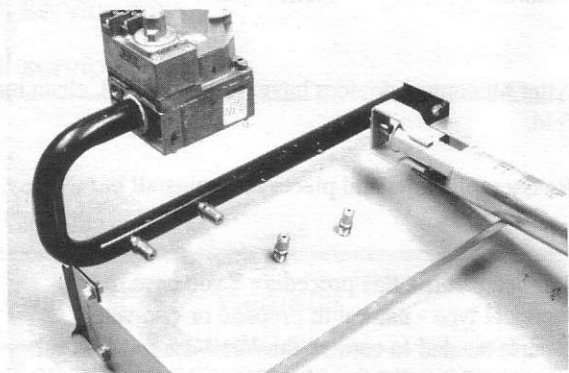

**Note:** If the heater has been off for the winter or has been installed, but not fires for an extended period of time, insect will crawl into these orifices and the pilot orifice and prevent the heater from firing.



12. Remove the pilot orifice and clean it (do not use any sharp object! It will destroy the designed orifice size!)

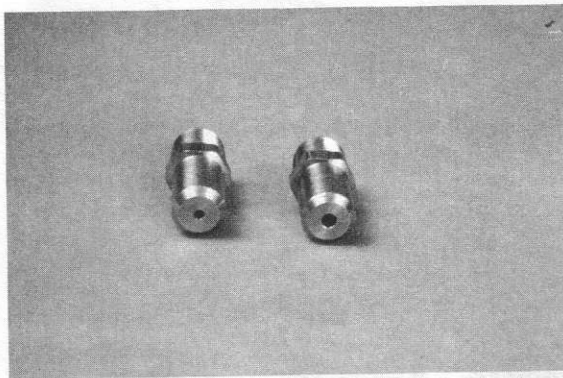
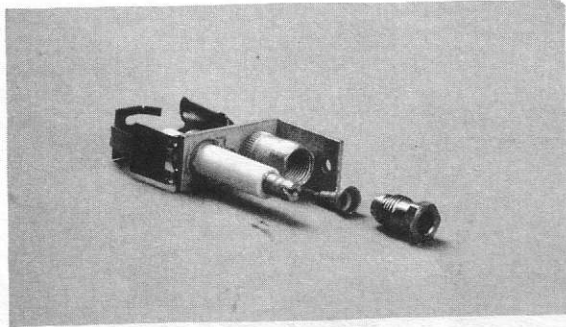

Installation of the high tension ignition wire is very important when reassembling the burner tray into the heater. The ignition wire must be pushed onto the ignition controller circuit board tightly and completely to assure proper spark at the pilot electrode during heater start-up.

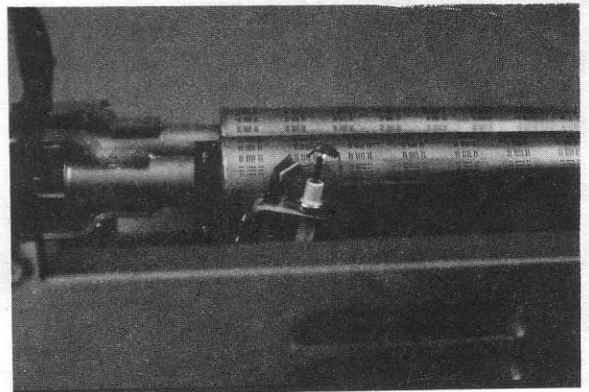
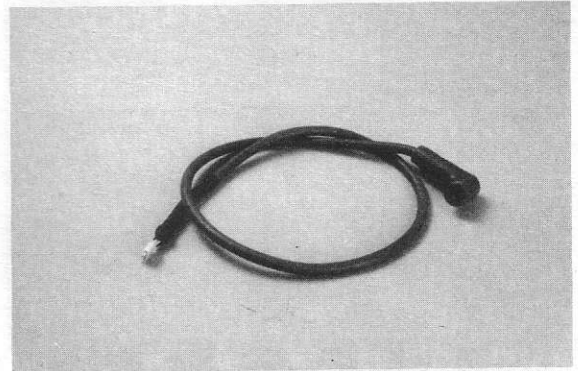

Main burner orifice: Natural large opening  
Propane small opening

Orifice size: MM	0-4,000 ft.	4,000 - 6000 ft
Natural	3.5mm (#29)	3.1mm (#31)

13. After all control devices have been removed, clean manifold.

14. Reassemble parts and pieces and reinstall burner tray.

**Note:** You can use this procedure if you have to change fuel type - natural to propane or visa-versa. The parts needed to convert the MiniMax are: Gas valve, pilot assembly, main burner orifices and module.

**TROUBLESHOOTING****HEATER WILL NOT COME ON**

Possible Cause	Remedy
Automatic ignition system fails	Check if electrical connections are correct and securely fastened- If YES, call serviceman.
Millivolt ignition fails	Check to see if pilot is lit. If not refer to "Operating Lighting instruction" - Millivolt.
Pump not running	Place pump in operation
Pump air locked	Check for leaks
Filter dirty	Clean filter
Pump strainer clogged	Clean strainer
Defective wiring or connection	Repair or replace wires
Overheat thermostat open	Manually reset button on thermostat
Defective pressure switch	Replace switch
Defective gas controls	Call serviceman
On - Off switch in "Off" position	Turn switch to "Pool" or "Spa"

**HEATER SHORT CYCLING (RAPID ON AND OFF OPERATION)**

Possible Cause	Remedy
Insufficient water flow	Clean filter and pump strainer
Defective wiring	Repair or replace wiring
Defective flow valve or out of adjustment	Call serviceman
Defective hi-limit and /or thermostat	Call serviceman

**HEATER MAKES KNOCKING NOISES****MAKE SURE ALL VALVES ON SYSTEM ARE OPEN**

Possible Cause	Remedy
Heater operating after pump has shut off	Shut off gas supply and call service man.
Heater exchanger scaled	Shut off gas supply and call serviceman.

## TROUBLESHOOTING - Heater Won't Spark

With the other voltmeter lead, touch each terminal or connection on the thermal overload, pressure switch and high limits. If voltage is present on both sides of these switches, they are operating properly.

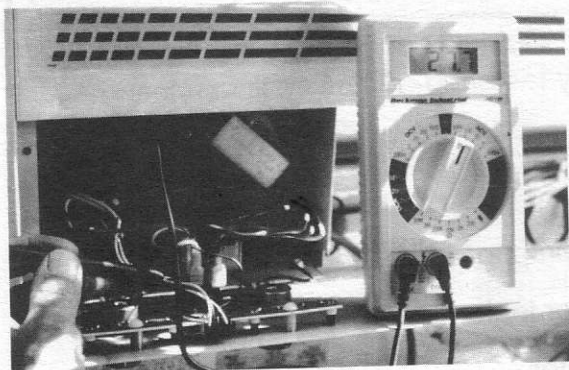

### Ignition Controller SparkTest

If there is still no pilot spark, turn power OFF and remove ignition wire from ignition controller circuit board (ICCB). Hold wire terminal close to ICCB terminal and turn power ON. If ICCB is good, there will be a strong 1/8" spark between ICCB and ignition wire. If the spark is weak or there is no spark, replace the ICCB.

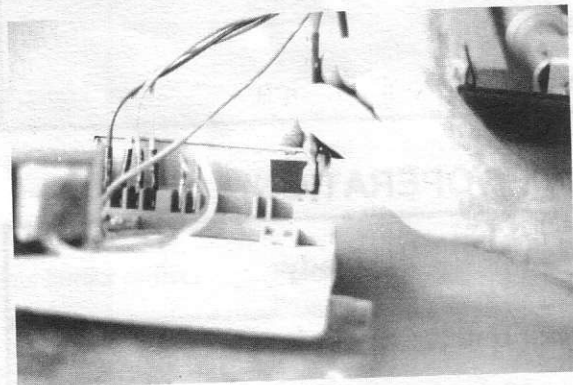

If there is a good spark between ICCB and wire terminal, turn power OFF and push ignition wire back on to the ICCB. Pull ignition wire and electrode assembly from pilot. Check condition of wire, if it is damaged, replace ignition wire/electrode. If ignition wire/electrode is OK, hold close to pilot assembly and turn power on. If a good spark is present between electrode and pilot assembly, wire is OK, if no spark, replace wire/electrode assembly.

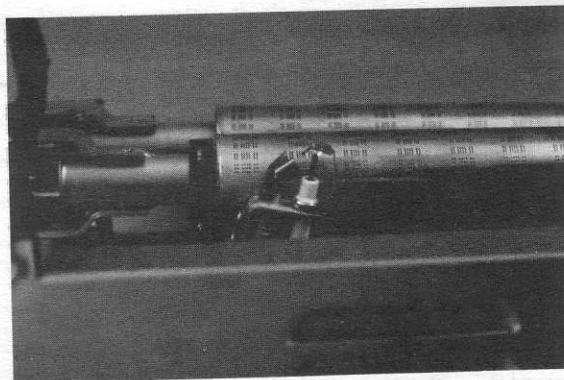
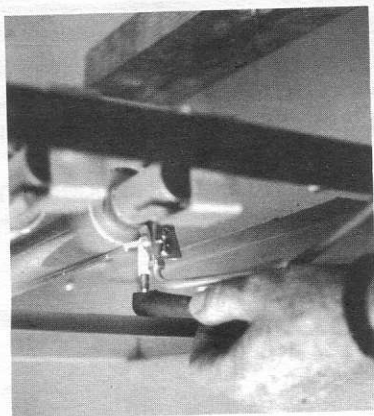

If you have a good spark between pilot assembly and electrode, push electrode back on pilot and turn power on. If you have good spark at pilot electrode, pilot is OK. If no spark or weak spark:

- Make sure pilot assembly is attached to the burner clean and tight to create a good ground.
- Make sure ceramic insulator is not cracked.
- Make sure electrode is clean. If still no spark, replace pilot assembly.
- Make sure spark gap is set properly.

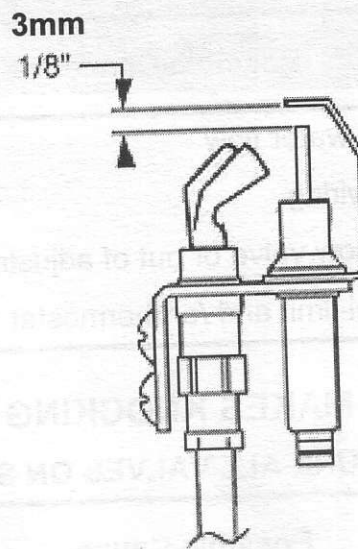

Fig. 22

## TROUBLESHOOTING - Heater Won't Fire - Pilot On

1. Check "all" wire connection to control and ground.
  - They should be clean and tight.
2. Check voltage at both terminals of thermal cutoff, pressure switch and hi-limit. If voltage is present on both terminals, these controls are OK.
3. Check voltage at ignition controller circuit board (ICCB).
4. Check voltage at gas valves (red wire). If voltage is present and heater doesn't fire, replace gas valve.

**Note:** Before replacing gas valve make sure main burner orifices are clean.

If no voltage present at red wire, replace ICCB.

## TROUBLESHOOTING - Heater Cycles Rapidly

**Do Not Replace Any Controls Before Reading These Instructions!**

### Preliminary checks:

1. Make sure pump is primed and you see adequate water flow.
  - A. If the water level in the pool is low, the pump will lose prime and reprime itself causing intermittent flow to heater, causing cycling.
  - B. If the filter is dirty, the water flow may fluctuate causing pressure switch to cycle.
  - C. If wind blows pilot flame away from electrode main burner will cycle on and off.
  - D. If flow valve is inoperative the heater will cycle.

**Note:** Turn power off. Place jumper wire across the high limit(s). Turn power on. If heater stops cycling problem is the water in header is too hot or high limit(s) is defective. If heater continues to cycle, problem is in wiring, grounding or another control.

2. Check wiring connections to gas valve; are they clean and on correct terminals.
3. Check ignition wire from ICCB to pilot assembly.
  - A. If ignition wire is loose at ICCB, heater will cycle.
  - B. Check all ground connection. IID heaters will cycle and operate erratically when not properly grounded.

### To check water related cycling

4. Check for correct heater flow from table 3, page 6.

If less than minimum required for model, the water will overheat and cause hi-limit to cycle.

5. The water temperature will also rise to 150 °F inside the header if there is too much restriction in the piping between the heater and the pool. This causes the water to slow down as it passes through the heat exchanger. The combustion temperature remains constant, so if the water speed decreases, the temperature increases.
6. If water is overheating, you can check actual temperature inside the header by installing a heater thermometer where the hose bib is now installed. This will tell you if the temperature is above the hi-limit will shut the heater off and then when the water temperature, the hi-limit will allow the heater to re-fire. This rapid cycle will range from 15 to 45 seconds.

**Note:** Temperature inside the header is controlled by the flow valve. If the water flow is low or close to minimum requirements, the flow valve forces most of the water into the heat exchanger keeping the temperature inside the header at an efficient level and below hi-limit shut off temperature. If the water flow is more than enough or close to maximum gallons per minute, the flow-valve remains relatively unaffected and allow enough water to by-pass so that the temperature inside the header stays at an efficient level.

**Conclusion:** If the flow valve was inoperative, the temperature inside the heater would reach hi limit shut off temperature and the heater would cycle rapidly. So after you have checked the electrical controls for bad ground or wiring, check the flow valve. **Note:** The flow-valve is located in the inlet/outlet header.

## TROUBLESHOOTING - Heater Cycles Rapidly (con't)

To check flow valve:

- A. Remove flow valve from header.

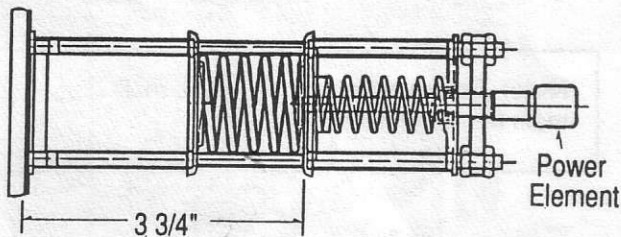

- B. Check factory measurement: 3 3/4" from mounting plate to the 2nd disc. (onside excluding gasket).

Note: Discs must be parallel with mounting plate.

- C. Check flow valve for any physical damage.

D. Hold power element under hot water and see if power element moves the discs towards the mounting plate 3.8" - 1/2".

E. Turn cold water on, power element should retract to original factory setting. If flow valve expands, retracts, and returns to original measurement, flow valve is OK.

The power element is the part of the flow valve that when heated, moves the 2 discs over toward the inlet, forcing more water into the heat exchanger and retracts when the water is cold, allowing water to bypass or return to the pool, without going into the exchanger. Here is a list of things that will cause the power element to fail and cause the heater to cycle on the hi-limit:

- A. If the pH of the water is too low, the power element will be eaten away and will not move.
- B. If the calcium hardness is too high, the power element will become coated with calcium deposits that will disable the flow valve.
- C. If power element has been installed incorrectly.
- D. If any debris in the circulation system were to pass by or through the filter and become lodged in the flow valve mechanism.

If water temperature inside IS NOT 150 °F and, all above tests have been completed and heater still cycles, the hi-limits should be replaced.

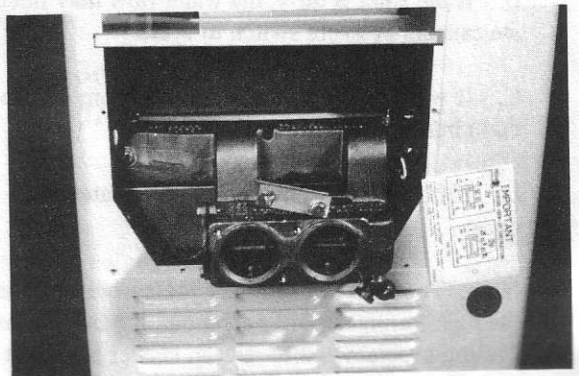
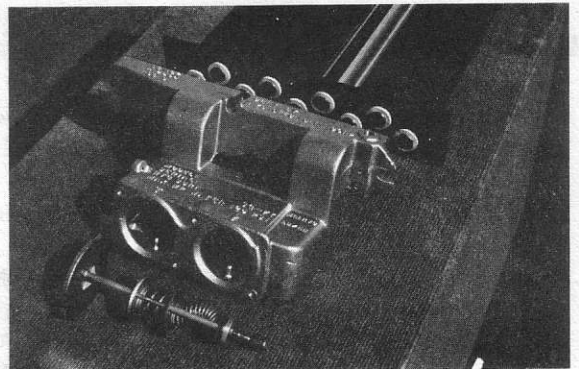

# MINIMAX HEATER - ALL MODELS

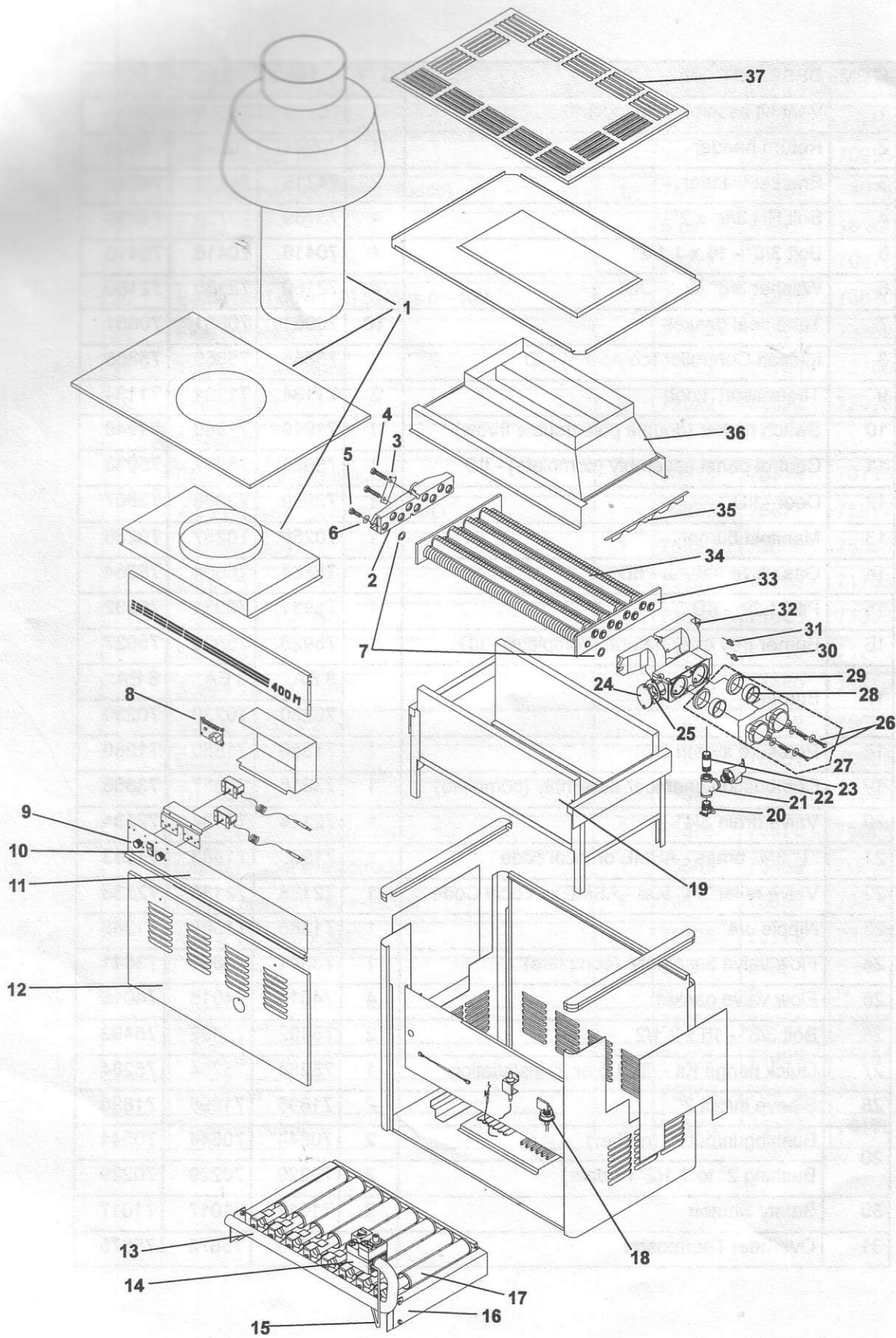

Fig. 23

## MiniMax Parts List

ITEM	DESCRIPTION	QTY	150	250	400
1	Vent kit assembly (indoor)	1	75979	75980	75981
2	Return header	1	70994	70994	70994
3	Bracket washer	2	74216	74216	74216
4	Bolt HH 3/8" x 2"	4	73739	73739	73739
5	Bolt 3/8" - 16 x 1 1/2"	4	70416	70416	70416
6	Washer 3/8" ID 1" OD	4	72180	72180	72180
7	Tube seal gasket	18	70951	70951	70951
8	Ignition Controller (complete) - ID	1	75865	75865	75865
9	Thermostat knob	2	71134	71134	71134
10	Switch rocker (double pole double throw)	1	71949	71949	71949
11	Control panel assembly (complete) - IID	1	75936	75937	75938
12	Door - IID	1	73869	73868	73867
13	Manifold burner	1	70256	70257	70258
14	Gas valve natural - IID	1	75864	75864	75864
15	Pilot tube - IID	1	75931	75931	75932
16	Burner tray assy natural (complete) - IID	1	75925	75926	75927
17	Burner		3 EA.	5 EA.	8 EA.
			70230	70230	70230
18	Pressure switch	1	71580	71580	71580
19	Combustion chamber assembly (complete)	1	73858	73857	73856
20	Valve drain 3/4"	1	72134	72134	72134
21	"T" 3/4" brass - ASME or local code	1	71983	71983	71983
22	Valve relief 3/4" 50# - ASME or Local Code	1	72138	72138	72138
23	Nipple 3/4"	1	71388	71388	71388
24	Flow valve assembly (complete)	1	73841	73841	73841
25	Flow valve gasket	4	74015	74015	74015
26	Bolt 3/8" - 16 x 2 1/2	2	75492	75492	75492
27	Quick flange Kit - fits 1.5 or 2" installation	1	75284	75284	75284
28	Sleeve in/out 2"	2	71895	71895	71895
29	Bushing in/out 2" (rubber)	2	70544	70544	70544
	Bushing 2" to 1 1/2" (rubber)	2	70229	70229	70229
30	Safety Shutoff	2	71017	71017	71017
31	Overheat Thermostat	1	75875	75875	75875

## MiniMax Parts List Cont.

ITEM	DESCRIPTION	QTY	150	250	400
32	Main header (in/out)	1	70985	70985	70985
33	Heat exchanger (Less Heads)	1	74452	74451	74074
34	Baffle		8 ea. 70277	8 ea. 70276	16 ea. 70278
35	Baffle hold down (2) baffles on 400	1	73810	73810	73810
36	Flue collector	1	73864	73863	73862
37	Top cover exhaust	1	73782	73781	73780
38	Thermostat	2	72022	72022	72022
<b>* Not Shown</b>					
*	Plastic mounting bracket		70715	70715	70715
*	Wire harness (gas valve) - IID		75877	75877	75877
*	Jumper Assy.	1	75890	75890	75890
*	Screw 8 x 1/4" HH		71703	71703	71703
*	Screw 8 x 1/2" HH		71698	71698	71698
*	Screw 6 x 1/4"		71716	71716	71716
*	Screw 10 -32 x 1/4"		71659	71659	71659
*	Screw 10-32 x 3/16		75692	75692	75692
*	Bushing 1/2"		70551	70551	70551
*	Therm knob stopper	2	71940	71940	71940
*	Wire harness (control box) - IID	1	75878	75878	75878
*	Ignition cable w/electrode	1	75869	75869	75869
*	Power element (flow-valve)	1	73656	73656	73656
*	Bolt 5/16" - 18 x 3/4'	2	73725	73725	73725
			3 ea. N	5 ea. N	8 ea. N
*	Orifice main burner natural		71465	71465	71465
*	Pilot - natural - IID	1	71465	71465	71465
*	Line Filter	1	75879	75879	75879
*	Thermal cutoff	1	75173	75173	75173



**Burner** - A device for final conveyance of gas, or a mixture of gas and air, to the combustion zone.

**Combustion** - The rapid oxidation of fuel gases accompanied by the production of heat or heat and light.

**Combustion Chamber** - The portion of an appliance within which combustion normally occurs.

**Controls** - Devices designed to regulate the gas, air, water or electricity supplied to a gas appliance. They may be manual, semiautomatic or automatic.

**Downdraught** - Excessive high air pressure existing at the outlet of chimney or stack with tens to make gases flow downward in the stack.

**Draft Divertor** - A device built into an appliance, or made part of a flue connector from an appliance, which is designed to: (1) assure the ready escape of the products of combustion in the event of no draft, backdraft, or stoppage beyond the draught divertor; (2) prevent backdraft from entering the appliance; and (3) neutralize the effect of stack action of a chimney or gas flue upon the operation of the appliance.

**Electronic Thermostats Components** - are made up of the **thermistor**, **potentiometer** and **circuit board**. The **thermistor** is installed in the inlet/outlet header to sense the incoming water temperature. The **potentiometer** is attached to the back of temperature adjustment knob. Both of these devices are connected to the **circuit board**. The concept is that by turning the **potentiometer** up or down a resistance level is established. The **thermistor** tries to match that level when the heater fires. The heat from the water changes the resistance in the thermistor.

**Flow Valve** - Installed in the inlet/outlet header; when the heater fires the sensing mechanism moves towards the inlet, forcing more water into the heat exchanger and mixes the water in the header so that the temperature is not too cold or not too hot, regulates temperature and minimizes condensation.

**Flue Gases, Flue Products** - Products of combustion and excess air in appliance flues or heat exchangers before the draft hood.

**Gas Valve** - A device that allows gas to flow from the gas supply line into the pilot assembly and into the main burners after receiving voltage from the module.

**Heat Exchanger** - Any device from transferring heat.

**High Limits or Safety Cutoffs** - Switches installed on the outlet side of the in/out header to prevent the water temperature inside the header from exceeding 150 degrees.

**Ignition Controller Circuit Board (ICCB)** - Device that sends and receives signals to other heater control. The ICCB starts the pilot and main burner sequence.

**ICCB Ignition Wire or Hi-Tension Wire** - Heavy duty wire attached to the ignition controller circuit board (ICCB) and the pilot ignitor that carries voltage to the pilot ignitor and back to the ICCB to signal the gas valve to open when the pilot flame is established.

## Glossary (con't)

**Input Rating** - The gas-burning capacity of an appliance in BTU per hour as specified by the manufacturer. Appliance input ratings are based on seal level operation and need not be changes for operation up to 2,000 feet elevation. For operation at elevations above 2,000 feet, input ratings should be reduced at the rate of 4 percent for each 1,000 feet above sea level.

**Liquefied Petroleum Gases** - The terms "Liquefied Petroleum Gases" "LPG" and "LP Gas" mean and include any fuel gas which is composed predominantly of any of the following hydrocarbons, or mixtures of them: propane, propylene, normal butane or isobutane and butylenes.

**Manifold** - The conduit of an appliance which supplies gas to the individual burners.

**Natural Gas** - Any gas found in the earth, as opposed to gases which are manufactured.

**Orifice** - An opening in an orifice cap (hood), orifice spud or other device through which gas is discharged, and whereby the flow of gas is limited and/or controlled.

**Pilot** - A small flame which is used to ignite the gas at the main burner.

**Pilot Ignitor or Pilot Assembly** - Establishes a pilot flame just prior to ignition of main burners.

**Pressure Switch** - A control that responds to water pressure. When the heater senses adequate water pressure the heater will fire and when the pressure drops below 1 1/2 PSI at the switch, the heater stops firing.

**Primary Air** - The combustion air introduced into a burner which mixes with the gas before it reaches the port. Usually expressed as a percentage of air required for complete combustion of gas.

**Propane** - A hydrocarbon gas heavier than methane but light than butane. It is used as a fuel gas alone, mixed with air or as a major constituent of liquefied petroleum.

**Soot** - A black substance, mostly consisting of small particles of carbon, which can result from incomplete combustion and appear as smoke.

**Therm** - A unit of heat energy equal to 1000,000 BTU.

**Thermal Cutoff** - A heat sensitive fuse that breaks the power to the controls if the temperature is too high in the gas valve area, causing the heater to switch off.

**Transformer** - A coil device that changes high voltage into low voltage.

**Flue** - A Device, such as a pipe, to transfer flue products from an appliance to the outdoors. This term also is used to designate a small hole or opening for the escape of a fluid (such as in a gas control).

**Water Column** - Abbreviated as W. C. - A unit used for expressing pressure.